

PST2200 Power System Trainer



CONTENT

	page
PST2200 Power Station and Transmission Laboartory - general.....	3-6
PST2210 Power Plant Module.....	7,9
PST2221 Transmission Lines Module	10
PST2230 Receiving Substation Module.....	11,12
PST2222 Distribution Lines Module.....	13
PST2240 Load Module.....	14
PST2280 Power Factor Controller.....	15
PST2212 Additional Power Generator.....	16,17
PST2231 Power Grid Switchgear Module.....	18,19
PST2291 Solar Power Module.....	20,21
PST2290 Wind Power Module.....	22
PST2250-150 Terco SCADA System Master Module.....	23,24
PST2250-1 Terco SCADA System Student Module.....	25
PST-Inst 1 Installation and Teacher Training.....	26

Guarantee & Terms

All overseas deliveries are dispatched in special, made to order wooden crates, extremely sturdy and damage resistant.

The guarantee is valid for 24 months from delivery and covers repair or exchange of parts, defective due to faulty design or workmanship at our factory.

Detailed conditions of guarantee are specified in our Terms of Guarantee.

Spare parts for 2-5 years of normal operation can be offered on request.

Regular after-sales service is performed by the worldwide network of Terco representatives, along with the advice and support of our engineers.

Commissioning and training is normally offered separately. Special training can be arranged on request either in Sweden or on site.

Terco is ISO 9001:2008 certified

Terco reserves the right to make changes in the design and modifications or improvements of the products at any time without incurring any obligations

PST2200 POWER STATION AND TRANSMISSION LABORATORY



PST2200 Power System Simulator with Two Generators, Solar and Grid System



PST2291 Solar Power Module

PST2200 General Introduction

The equipment is built upon free standing modules which can be operated separately, and one SCADA System Module.

Each module is equipped with 4 wheels (2 lockable), and separate power input / output, which means that the modules are fully mobile and can work independently if desired.

Linked together they constitute a complete power system and contain everything needed to teach and train students as well as engineers how electrical power systems work - from generation to utilization.

The system can be supplemented at any time with the other modules.

The modular system will make it possible to arrange experiment scenarios covering real situations with a complexity designed and adjusted to the aims and knowledge level of the students. Adaptation to other conditions as well as partial upgrading is done fast and easily.

The Modules hold an advanced measurement system where each three-phase transducer comprises 20 parameters, where also non-symmetrical behaviour as well as $\cos \phi$ are displayed. This extensive environment can also be studied on the TERCO SCADA-System.

Facilities allowing Power Utilities to give new Trainees necessary skills and experience before getting hands on experience in Power Plants, Transmission and Distribution Systems.

Also giving Staff the necessary training in emergency situations under safe conditions. TERCO works in close cooperation with ABB the world leading corporation in power systems, and consequently using their protection relays. As standard we are using ABB IED Relion series of protection relays. IED stands for Intelligent Electronic Device and is state of the art of protection relays. These protection relays are fully compliant with the World Wide Power Industry Standard, IEC61850.

The Power System Simulator PST2200 includes basic modules and additional modules.

Protection Relay

All the Protection Relays (IED) are constituted by the ABB RELION SERIES which are the same as used in modern power installations. Each relay is pre-configured at the TERCO factory to optimise the functionality of each module.

IED stands for Intelligent Electronic Device and is State of the Art of protection relays. It is fully compliant with the World Wide Power Industry Standard IEC 61850



Protection Relay

3-phase Instruments

Strategically placed 3-phase power network parameter analyzers displaying 20 power energy quantities divided into five selectable pages (each page displaying 4-parameters at a time), featuring for instance:

- Average 3-ph voltage/current
- Visualisation of non symmetrical loads
- Both phase-phase and phase-earth voltages
- Independent phase currents
- Average 3-ph active, reactive and apparent power
- Independent phase active, reactive and apparent powers
- Average 3-ph power factor
- Independent phase power factors
- Active, reactive and apparent energy



3-phase Instruments

Bargraphs

Digital bargraphs, each with dual graphs (one for each busbar) comprise the ability to monitor essential parameters for synchronization purposes:

- Voltage - both busbars monitored with LED's and bargraphs (normally 380-420VAC)
- Frequency - both busbars displayed with LED's and bargraphs (normally 45-55Hz)
- Display levels selectable in three different colours for highlighting of significant values

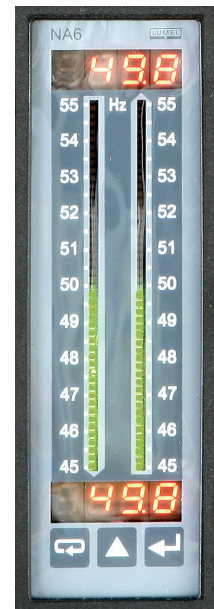

Bargraphs

AC Drive Control Panel

Displaying:

- Frequency command (Hz)
- Output frequency
- Actual motor speed
- Output current
- Start-up time delay selector switches

AC Drive Control Panel

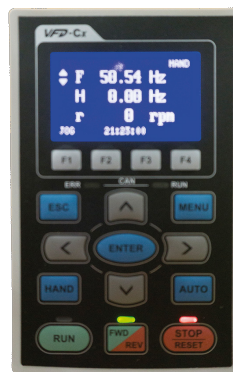

Single Phase Instruments

Single Phase Instruments

- Two instruments for voltages on A- and B-busbars
- Phase-phase and phase-earth by means of selector switch
- Generator magnetizing

Synchronization Instrument

Displaying:

- Phase angle
- Main- and generator voltage delta (dU)
- Earth leakage voltage
- Main- and generator frequency delta (dF)
- Frequency differency
- Phase Sequence Indicator
- Traditional 3-lamp Sequencing Indication



Synchronization Instrument

PST2250-15 SCADA System



PST2252-1 TERCO SCADA System Student Module.

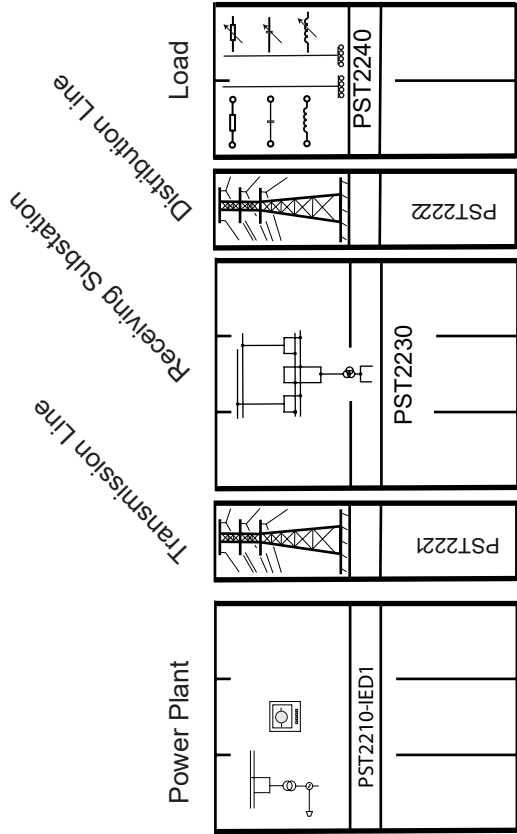

Basic System

The picture above shows a standard Power System Simulator with turbine-generator, power plant section, transmission lines, receiving substation and the load module incl. an induction motor with flywheel.



PST2250-15 SCADA System



PST2252-1 TERCO SCADA System Student Module.

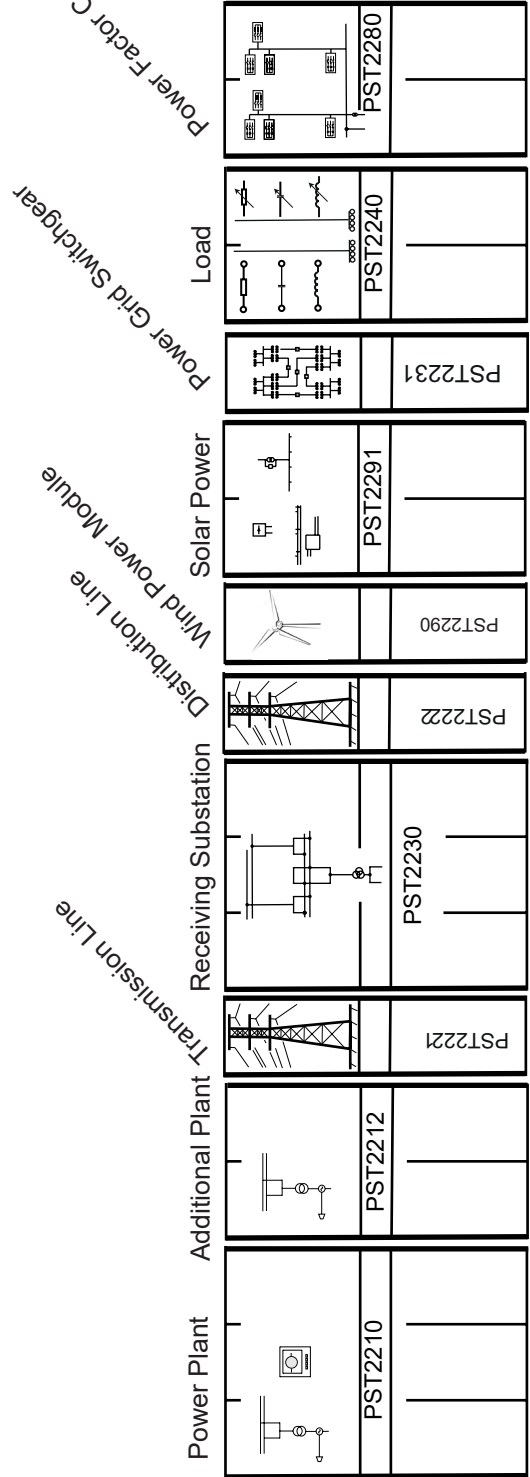

Weights and Dimensions

Each module consists of one, two or three sections. The dimensions and weights can vary slightly with new components.

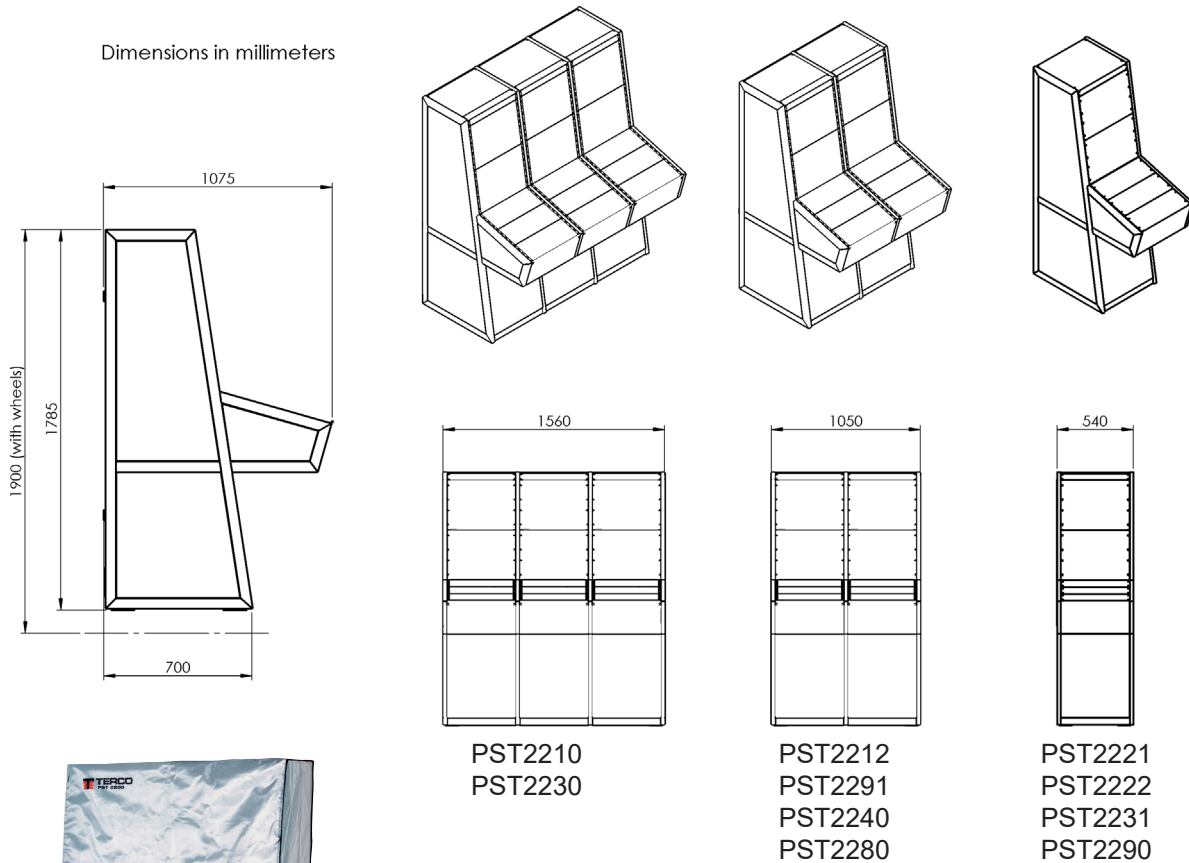

Each Module is delivered with a PVC-coated polyester fabric.

Power Supply

400V 3-phase, 16A. Each module connects 5 pole (L1, L2, L3, N, Earth) with CEE connection.

The modules Power Supply can be daisy-chained so that only one Power outlet is required

Product no	Description	Weight kg
PST2210	Power Plant Module	360
	(Turbine/Generator)	90
PST2221	Transmission Lines Module.	166
PST2230	Receiving Substation Module	360
PST2222	Distribution Lines Module	132
PST2240	Load Module	242
PST2280	Power Factor Controller	212
PST2212	Additional Power Plant Module	245
	(Turbine/Generator)	90
PST2231	Power Grid Switchgear Module	132
PST2290	Wind Power Module	
	Mast	
PST2291	Solar Power Module	245
	(Photovoltaic Module/unit. Tot. 3 units)	22/unit

PST2210 Power Plant Module



The picture shows PST2210 IED Level 2

General

Power Plant with 2.2 kW 3-phase AC Induction Motor and Field Oriented Programmable Drive for simulating a turbine with different characteristics as:

- Steam turbine (nuclear, geothermal, fossil)
- Hydro-electric turbine
- Small diesel motor

The three-phase 1.2 kVA synchronous generator has electrical parameters similar to real units.

Manual or automatic control both for the frequency (=active power) and the voltage (=reactive power). One-line mimic diagrams together with power breakers and isolators and groups of digital instruments arranged in the same way as in real plants.

The PST2210-module has also synchronization and phasing devices, digital bar-graphs for voltage and frequency, step-up transformer, current and voltage transformers, relay protections, A and B bus bars with two outgoing lines.

Operation of breakers and isolators is controlled and interlocked by PLC's for safe operation by students. The step-up transformers can be operated individually and all terminals are available from the front panel providing access to delta and star-connected windings.

Access to the generator windings are provided on the front panel.

Protection relay current transformer windings are accessible on the front panel via external connectors. Possibility for floating, impedance and direct-earthing of transformer and generator is available on front panel.

PST2210 contains a fault simulator with the ability to simulate variable short circuit and earth faults.

The module includes 4, 8-pole Transfer Blocks for easy signal transfer between different compatible modules.

Possible earthing methods:

- a) Solid earth
- b) Resistive earth
- b) Floating earth

....continuation PST2210 Power Plant Module

Technical Specifications

Simulating different types of power plant units:

- Induction Motor 2.2 kW @ 50 Hz, 2.6 kW @ 60 Hz
- Fully programmable AC Drive with HMI for Speed/W control

Step-up Transformer

- Step-up Transformer 230 / 400 V, 2.0 kVA

Generator Data:

- 4-pole Synchronous Generator, 1.2 kVA, cos phi 0.8
- Static PWM rectifier for Voltage / VAR control
- Voltage: 3 x 230 V
- Nominal Current: 3.5 A
- Frequency: 50 Hz / 60 Hz
- Speed: 1500 rpm / 1800 rpm
- Synchronous Reactance 97 %
- Transient Reactance 17 %
- Sub Transient Reactance 8 %

Digital Instruments:

Multiple 3-ph Power Energy Meters displaying 20 values for U, I, P, Q, S, and cos phi is used for:

- Generator
- Step-up Transformer
- Outgoing Lines 1+2
- External Grid

Selectable-line Double-busbar Voltmeters:

- Field Current
- Rpm
- Frequency (Set point, actual)
- Synchroscope for Phase Position, Δ frequency and Δ voltage
- Bargraphs for Voltage and Frequency

Number and type and configuration of the ABB **Intelligent Electronic Devices** (IED) are different depending on the complexity or **Level** that is desired.

Included in all levels:

- IEC61850 GOOSE device information sharing capability
- Easy Parameter Setting Via Web Browser
- Disturbance Recording for in-depth fault analysis

Measurements

Cubicle	WxHxD	1560x1900x1075 mm
Weight		360 kg

Turbine/Generator

Cubicle	WxHxD	300x560x1500 mm
Weight		90 kg

Power Supply

400V 3-phase, 16A. Each module connects 5 pole (L1, L2, L3, N, Earth) with CEE connection.

Monitoring and control of the modules are connected in a Local Area Network.



The modules Power Supply can be daisy-chained so that only one Power outlet is required



Protection Relays

PST2210 Level 1

IED Transformer + Generator Protection (1 unit - RET630):

- Differential Protection
- Over/Under Voltage Protection
- Frequency Protection (Over/Under/Gradient)
- Negative Sequence Overcurrent Protection
- Neutral Point Earth Fault Protection (Residual Over-Current)
- Neutral Point Earth Fault Protection (Residual Over-Voltage)
- HV / MV Overcurrent Protection

*1 Protection unit in total

PST2210 IED Level 2

IED Transformer + Generator Protection (1 unit - RET630):

- Differential Protection
- Over/Under Voltage Protection
- Frequency Protection (Over/Under/Gradient)
- Negative Sequence Overcurrent Protection
- Neutral Point Earth Fault Protection (Residual Over-Current)
- Neutral Point Earth Fault Protection (Residual Over-Voltage)
- HV / MV Overcurrent Protection

IED Outgoing HV Line 1 & 2 Multi-Protection (2 units – REF615):

- Directional Three-Phase Overcurrent Protection
- Directional Earth Fault Protection
- Three-Phase Overcurrent Protection
- Non-Directional Earth Fault Protection
- Negative Sequence Overcurrent Protection
- Phase Discontinuity Protection
- Negative Sequence Overcurrent Protection
- Auto Reclosing Function

*3 Protection units in total

PST2210 Level 3

IED Transformer + Generator Protection (1 unit - RET630):

- Differential Protection
- Over/Under Voltage Protection
- Frequency Protection (Over/Under/Gradient)
- Negative Sequence Overcurrent Protection
- Neutral Point Earth Fault Protection (Residual Over-Current)
- Neutral Point Earth Fault Protection (Residual Over-Voltage)
- HV / MV Overcurrent Protection

IED Dedicated Generator Protection

(1 unit - RET615):

- Differential Protection
- 95% Stator Earth Fault Protection

IED Incoming HV Line 1 & 2 Multi-Protection

(2 units - REF630):

- Distance Protection
- Directional Earth Fault Protection
- Directional Three-Phase Overcurrent Protection
- Non-Directional Three-Phase Overcurrent Protection
- Non-Directional Earth Fault Protection
- Phase Discontinuity Protection
- Negative Sequence Overcurrent Protection
- Reverse Power Protection
- Auto Reclosing Function

*4 Protection units in total

PST2221 Transmission Lines Module

General

PST2221 has 4 scaled down 3-phase OH transmission lines (3 different) with possibilities to change and combine impedance elements to constitute other Overhead Lines (OH) High Voltages (HV) levels.

All models have coils, capacitors and resistors designed to withstand overload and surges for dynamic as well as for static experiments.

All parameters of the transmission models can be changed easily by both internal and external combinations, together with the possibilities of arranging the models in series, parallel or in grid networks.

Each artificial line model consists of a three-phase pi-link and an earth link.

Technical Specifications

One OH- π link	400 kV	700 MVA	400 km	0.04 p.u.
Two OH- π link	230 kV	110 MVA	100 km	0.03 p.u.
One OH- π link	110 kV	80 MVA	75 km	0.08 p.u.

With our Transmission Line Modules, we have a unique combination of HV-lines, Medium-Voltage lines, OH-distribution Voltage lines and Distribution Voltage cables which will enable studies of the typical parameters and characteristics within the four main groups of AC-power transmission and corresponding need of compensation.

It is possible to isolate/separate the different R, L, and C characteristics of each line for individual analysis.

All line models have the same ratings in the model scale: 400 V, 2A.

All line models also have parallel four pole blocks to provide easy facilities of connection.

Measurements

Cubicle	WxHxD	540x1900x1075 mm
Weight		166 kg

Power Supply

400V 3-phase, 16A. Each module connects 5 pole (L1, L2, L3, N, Earth) with CEE connection



PST2230 Receiving Substation Module

General

Receiving Substation with two HV-incoming lines, HV-busbars arrangement, step-down transformer, two middle voltage bus bars and two outgoing feeders including a complete switch board with instruments and corresponding protection relays. Three or more incoming lines and three or more outgoing lines can be delivered as option as well as extra distribution transformers.

Phases L1, L2, and L3 are accessible on the middle voltage bus bars and feeders via 4 mm safety sockets, enabling to connect PST 2230 directly to a network or to a generator as well as to external loads.

All breakers and isolators are operated by contactor relays via a logical interlocking and tripping system to avoid accidents that may occur due to accidental connections.

PST2230 contains fault simulator with the ability to simulate variable short circuit and earth faults.

The module includes 4, 8-pole Transfer Blocks for easy signal transfer between different compatible modules.



The picture shows PST2230 IED Level 2

The step down transformer is a 2 kVA Yyn + d transformer with an On-Line Tap Changer (OLTC) for dynamic voltage regulation via 2.5% incremental tapping's from 95% to 105 % on the secondary winding. The step-down transformer also includes a delta winding to help protect the upstream equipment in unbalanced load conditions.

Possible earthing methods:

- a) Solid or resistive earth
- b) Floating earth
- c) Petersen coil (multiple)

The step down transformer can be operated individually and all windings are available via terminals on the front.

Current transformers are positioned around the transformer and the connections are available from the front panel.

Technical Specifications:

Digital Instruments:

Multiple 3-ph Power Energy Meters displaying 32 values for U, I, P, Q, S, cos phi is used for:

- Dual incoming HV lines
- Step-down Yyn + d transformer
- Dual outgoing MV feeders

Voltmeter instrument for measuring between bus bars on incoming power.

Measurement point selectable by means of a switch.

Number, type and configuration of the **ABB Intelligent Electronic Devices (IED)** are depending on the complexity or Level that is desired.

The modules Power Supply can be daisy-chained so that only one Power outlet is required



Protection Relays

PST2230 IED Level 1

IED Transformer Protection (1 unit - RET630):

- Differential Protection
- Over/Under Voltage Protection
- Frequency Protection (Over/Under/Gradient)
- Negative Sequence Overcurrent Protection
- Neutral Point Earth Fault Protection (Residual Over-Current)
- Neutral Point Earth Fault Protection (Residual Over-Voltage)
- HV / MV Overcurrent Protection

*1 Protection units in total

PST2230 IED Level 2

IED Transformer Protection (1 unit - RET630):

- Differential Protection
- Over/Under Voltage Protection
- Frequency Protection (Over/Under/Gradient)
- Negative Sequence Overcurrent Protection
- Neutral Point Earth Fault Protection (Residual Over-Current)
- Neutral Point Earth Fault Protection (Residual Over-Voltage)
- HV / MV Overcurrent Protection

IED Incoming HV Line 1 & 2 Multi-Protection (2 units - REF615):

- Directional Three-Phase Overcurrent Protection
- Directional Earth Fault Protection
- Three-Phase Overcurrent Protection
- Non-Directional Earth Fault Protection
- Negative Sequence O/C Protection
- Phase Discontinuity Protection
- Negative Sequence Overcurrent Protection
- Auto Reclosing Function

IED Outgoing Feeder 1 & 2 Multi-Protection (2 units - REF615):

- Three-Phase Overcurrent Protection
- Negative Sequence Overcurrent Protection
- Directional Earth Fault Protection
- Non-Directional Earth Fault Protection
- Phase Discontinuity Protection
- Auto Reclosing Function

*5 Protection units in total

PST2230 IED Level 3

IED Transformer Protection (1 unit - RET630):

- Differential Protection
- Over/Under Voltage Protection
- Frequency Protection (Over/Under/Gradient)
- Negative Sequence Overcurrent Protection
- Neutral Point Earth Fault Protection (Residual Over-Current)
- Neutral Point Earth Fault Protection (Residual Over-Voltage)
- HV / MV Overcurrent Protection

IED Incoming HV Line 1 & 2 Multi-Protection (2 units - REF630):

- Distance Protection
- Directional Earth Fault Protection
- Directional Three-Phase Overcurrent Protection
- Non-Directional Three-Phase Overcurrent Protection
- Non-Directional Earth Fault Protection
- Phase Discontinuity Protection
- Negative Sequence Overcurrent Protection
- Reverse Power Protection
- Auto Reclosing Function

IED Outgoing Feeder 1 & 2 Multi-Protection (2 units - REF615):

- Three-Phase Overcurrent Protection
- Negative Sequence O/C Protection
- Directional Earth Fault Protection
- Non-Directional Earth Fault Protection
- Phase Discontinuity Protection
- Negative Sequence Overcurrent Protection
- Auto Reclosing Function

*5 Protection units in total

Included in all levels:

- IEC61850 GOOSE device information sharing capability
- Easy Parameter Setting Via Web Browser
- Disturbance Recording for in-depth fault analysis

Measurements

Cubicle	WxHxD	1560x1900x1075 mm
Weight		360 kg

Power Supply

400V 3-phase, 16A. Each module connects 5 pole (L1, L2, L3, N, Earth) with CEE connection



PST2222 Distribution Lines Module

General

PST2222 has 3 scaled down 3-phase Overhead Lines (OH) transmission lines (2 different) and one underground cable link with possibilities to change and combine impedance elements to constitute other OH High Voltages (HV) levels as well as cable models for distribution.

All models have coils, capacitors and resistors designed to withstand overload and surges for dynamic as well as for static experiments.

All parameters of the transmission models can be changed easily by both internal and external combinations, together with the possibilities of arranging the models in series, parallel or in grid networks.

Each artificial line model consists of a three-phase pi-link and an earth link.

Technical Specifications

Two OH- π link	33 kV	20 MVA	20 km	0.05 p.u.
One OH- π link	11 kV	5 MVA	5 km	0.04 p.u.
One Cable- π link	11 kV	5 MVA	5 km	0.04 p.u.

With our Distribution Modules, we have a unique combination of HV-lines, Medium-Voltage lines, OH-distribution Voltage lines and Distribution Voltage cables which will enable studies of the typical parameters and characteristics within the four main groups of AC-power transmission and corresponding need of compensation.

Each model can either be studied as a six- or eight pole block or in itself component by component.

It is possible to isolate/separate the different R, L, and C characteristics of each line for individual analysis.

All line models have the same ratings in the model scale: 400 V, 2A.

All line models also have parallel four pole blocks to provide easy facilities of connection.

Measurements

Cubicle	WxHxD	540x1900x1075 mm
Weight:		132 kg

Power Supply

400V 3-phase, 16A. Each module connects 5 pole (L1, L2, L3, N, Earth) with CEE connection

PST2240 Load Module

Single Phase Loads

Three Phase Loads

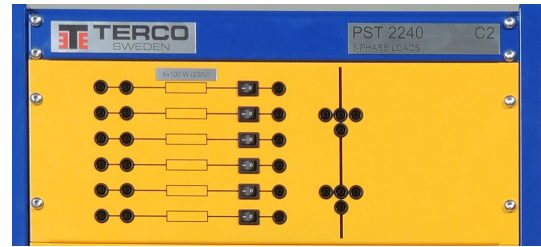

Single Phase Loads

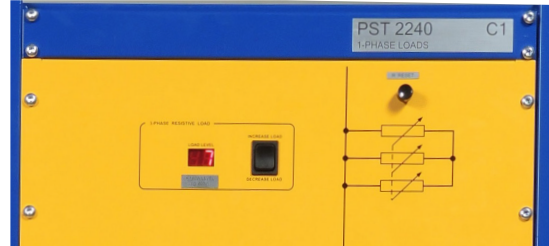

Three Phase Loads



General

Dynamic 3-ph loads with built in simulation of real load trends. A real time of 24h can be simulated down to two minutes.

The Low Voltage Distribution is constituted by bus bars to which the substation can be connected by the outgoing lines or by one or more transmission models.

The Load Module consists of groups of single phase and three-phase industrial and domestic loads.

The loads are of resistive, capacitive, inductive and active (motor) types: Three 3-phase groups can be varied in small steps which together with the other loads will cover load possibilities from 0-150 % of nominal power.

Single-phase distribution groups are available by 4 mm safety outlets to which loads can be connected with or without external instruments.

These single-phase groups enable possibilities to create single-phase loads as well as other non-symmetrical loads.

Power Supply

400V 3-phase, 16A. Each module connects 5 pole (L1, L2, L3, N, Earth) with CEE connection. The modules Power Supply can be daisy-chained so that only one Power outlet is required

Technical Specifications

Digital instruments:

Multiple 3-ph Power Energy meters displaying 20 values for U, I, P, Q, S, and cos phi for use on loads, but connectable at any desired location.

The Loads:

- Six resistive 1-phase load groups connect-able by switches
- Six capacitive 1-phase load groups connect-able by switches
- Six inductive 1-phase load groups connect-able by switches
- One 18 step 3-phase resistive load bank controlled by increase / decrease switch, SCADA or Time-scaled real-life switching schedule
- One 13 step 3-phase capacitive load bank controlled by increase / decrease switch or SCADA
- One 13 step 3-phase inductive load bank controlled by increase / decrease switch or SCADA

Measurements

Cubicle	WxHxD	1050x1900x1075 mm
Weight		242 kg

PST2280 Power Factor Controller



General

With the Power Factor Controller the currents caused by reactive power losses can be minimized, and thereby optimizing the transfer of energy between generation and load. This is getting more and more important when "saving energy" is vital in a world with focus on pollution and shortage of energy.

Technical Specifications

Number of 3-ph groups:

- 12 capacitive
- 2 inductive

Power Factor Setting:

- 0.7 inductive to 0.7 capacitive
- Nominal voltage - 3x400 V, 50-60 Hz
- Nominal power - 0 - 2 kVAr cap., 0 - 2 kVAr ind.

PF-Controller with touch screen (HMI):

- Automatic or manual modes
- Adjustable delay times, switching sequences and strategies

Monitoring and Measurement on the Controller:

- Power factor (compensated)
- Switching modes - linear, circular
- Panel mounted digital instruments
- Voltmeter (RMS)
- Ammeter (RMS)

Parameter Trend Visualization in graph form on HMI

Digital Instruments:

- Incoming 3-phase current
- Outgoing 3-phase current
- Power Factor Downstream (uncompensated)
- Bank branch 3-phase currents

Power Supply:

- 1-ph 220 - 240 V 50-60 Hz (internally supplied)

Measurements

Cubicle	WxHxD	1050x1900x1075 mm
Weight		212 kg

Power Supply

400V 3-phase, 16A. Each module connects 5 pole (L1, L2, L3, N, Earth) with CEE connection

The modules Power Supply can be dasy-chained so that only one Power outlet is required



General

Power Plant with 2.2 kW 3-phase AC Induction Motor and Field Oriented Programmable Drive for simulating a turbine with different characteristics as:

- Steam turbine (nuclear, geothermal, fossil)
- Hydro-electric turbine
- Small diesel motor

The three-phase 1.2 kVA synchronous generator has electrical parameters similar to real units.

Manual or automatic control both for the frequency (=active power) and the voltage (=reactive power).

One-line mimic diagrams together with power breakers and isolators and groups of digital instruments arranged in the same way as in real plants.

The PST2212-module has step-up transformer, current and voltage transformers, relay protections for generator and transformer, A and B bus bars.

Operation of breakers and isolators is controlled and interlocked by PLC's for safe operation by students.

The step-up transformers are operated individually and all windings can be available via terminals on the front panel.

All necessary current transformers and voltage transformers are included and the necessary windings accessible via terminals on the front panel.

Possible earthing methods:

- a) Solid earth
- b) Resistive earth
- c) Floating earth



Technical Specifications

Simulating different types of power plant units:

- Induction Motor 2.2 kW @ 50 Hz, 2.6 kW @ 60 Hz
- Fully programmable AC Drive with HMI for Speed/W control

Step-up Transformer:

- Step-up Transformer 230 / 400 V, 2.0 kVA

Generator Data:

- 4-pole Synchronous Generator, 1.2 kVA, cos phi 0.8
- Static PWM rectifier for Voltage / VAr control
- Voltage: 3 x 230 V
- Nominal Current: 3.5 A
- Frequency: 50 Hz / 60 Hz
- Speed: 1500 rpm / 1800 rpm
- Synchronous Reactance 97 %
- Transient Reactance 17 %
- Sub transient Reactance 8 %

Digital Instruments:

Multiple 3-ph Power Energy Meters displaying 32 values for U, I, P, Q, S, and cos phi is used for:

- Generator
- Step-up Transformer
- Field Current
- Rpm
- Frequency (Set point, actual)

Included:

- IEC61850 GOOSE device information sharing capability
- Easy Parameter Setting Via Web Browser
- Disturbance Recording for in-depth fault analysis

Measurements

Cubicle WxHxD 1050x1900x1075 mm
Weight 245 kg

Turbine/Generator

Cubicle WxHxD 300x560x1500 mm
Weight 90 kg

Power Supply

400V 3-phase, 16A. Each module connects 5 pole (L1, L2, L3, N, Earth) with CEE connection

The modules Power Supply can be dasy-chained so that only one Power outlet is required

Protection Relays

PST2212 Level 1 IED Transformer + Generator Protection (1 unit - RET630):

- Differential Protection
- Over/Under Voltage Protection
- Frequency Protection (Over/Under/Gradient)
- Negative Sequence Overcurrent Protection
- Neutral Point Earth Fault Protection (Residual Over-Current)
- Neutral Point Earth Fault Protection (Residual Over-Voltage)
- HV / MV Overcurrent Protection

*1 Protection unit in total

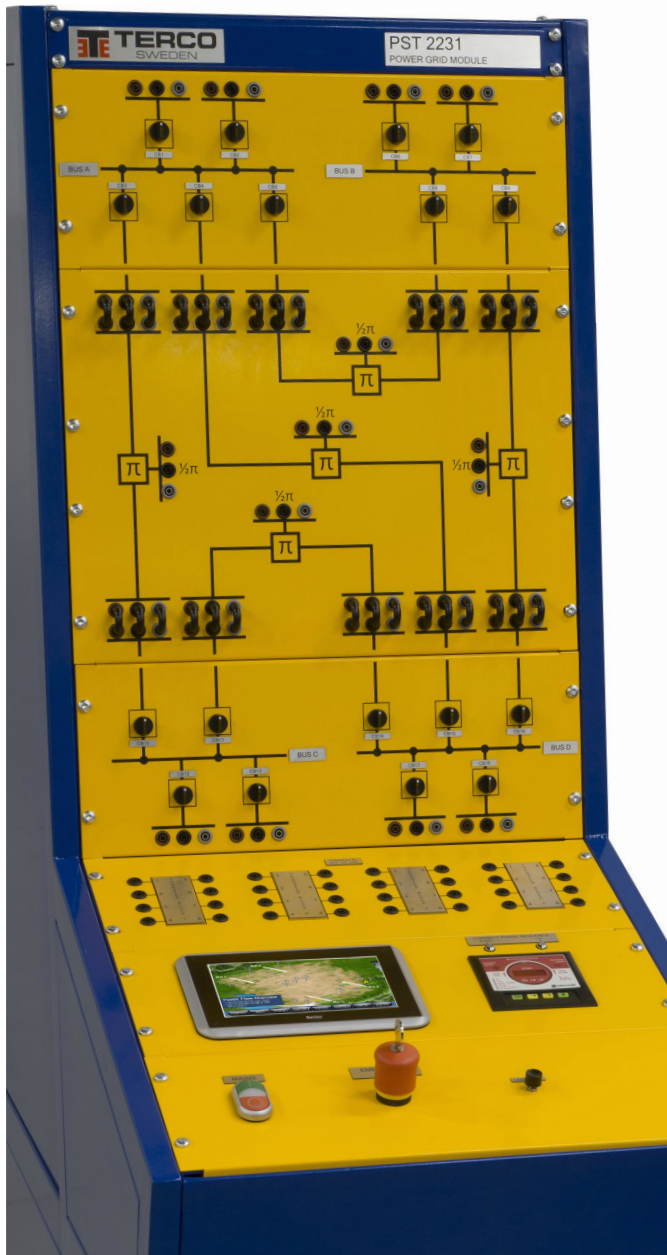

General

PST2231 allows the user to interconnect several power sources and loads to simulate a transmission and distribution grid.

The unit consists of 5 high voltage OH transmission line models connecting 4 different HV buses. Each bus has 2, 3-phase terminals for the connection of various power sources and loads. Full control is obtained by 18 inbuilt circuit breakers and a dynamic synchronization system.

The synchronization system connects multiple power sources into a live system at any of the 18 inbuilt breakers. Synchronization is controlled from the Human Machine Interface (HMI) touch screen operator panel.

Each circuit breaker is fully monitored via advanced 3-phase power network transducers. Each transducer provides more than 20 power network parameters each, to enable complete monitoring of the network status at all points.

The monitored quantities are to be presented on the HMI, showing the power flow at each point in the network simultaneously.

Each Transmission line model is split into 2 sections and is equipped with connection terminals at halfway, to allow faults such as short-circuits and earth faults to be connected at midway in the transmission line.

Technical Specifications

Digital Instruments

- Synchroscope
- Three-phase instruments (V,A,W,VAR)

Busbars

PST2231 has 4 buses where each allows 2 incoming power sources or outgoing loads. Each bus also has 2-3 outgoing feeders which can be used to connect the transmission lines to other buses in PST2231. Each incoming or outgoing feeder is controlled via a local circuit breaker.

Power Lines

PST2231 has 5 transmission lines consisting of two π link models in series with front panel and access to the midpoint of each line for fault simulations on the line.

HMI

The touch screen HMI provides the user with measurements of over 20 power network parameters at each of the 18 switchgear cubicles. These parameters, when viewed together, provide an overview of the power flow at all points in the network simultaneously.

Features

- Enables interconnection of several PST2200 systems or parts thereof (e.g. PST2210)
- Synchronization with line selector switch
- Simulation of a large power grid
- Possibility to create a redundant power grid and study the operation of faulty transmission lines
- 4 transfer blocks for interconnection with other PST2200 modules

Measurements

Cubicle	WxHxD	540x1900x1075 mm
Weight		132 kg

Power Supply

400V 3-phase, 16A. Each module connects 5 pole (L1, L2, L3, N, Earth) with CEE connection. The modules Power Supply can be daisy-chained so that only one Power outlet is required

...continuation PST2231 Power Grid Switchgear Module

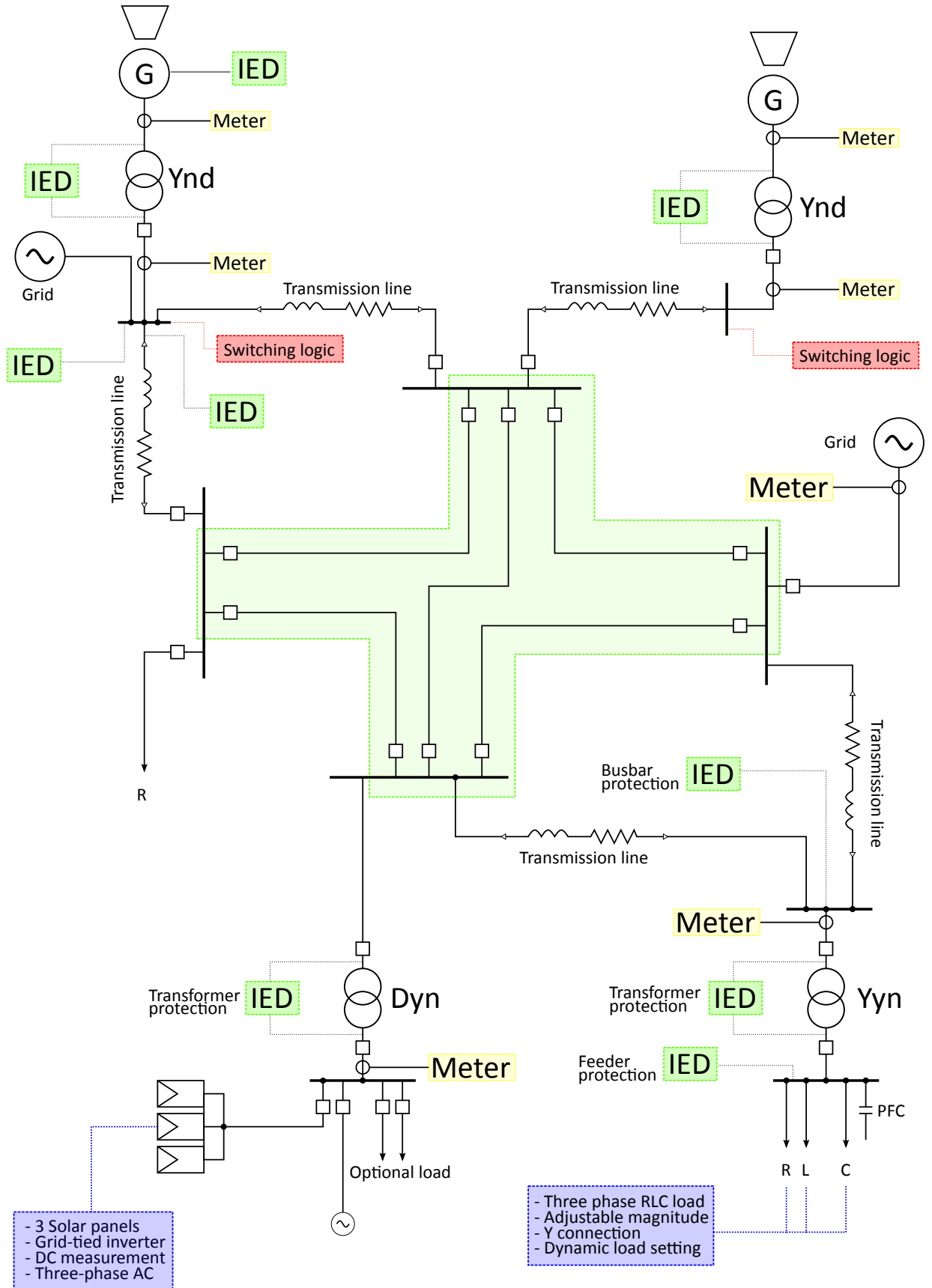

The sketch shows how multiple power systems can be linked together using PST2231

PST2291 Solar Power Module



Power Supply

400V 3-phase, 16A. Each module connects 5 pole (L1, L2, L3, N, Earth) with CEE connection. The modules Power Supply can be dasy-chained so that only one Power outlet is required



General

PST2291 is a free standing module with the same form factor as the other modules. PST2291 is a generator station where the generator consists of three solar panels delivering three-phase power to the module that can further be tied to a grid.

The grid may be a complete PST2200 system or simply the public three-phase grid. PST2291 can be linked together with existing PST2200 modules to form a larger and complete power system with the addition of solar power.

The module simulates a solar farm, containing all necessary equipment such as solar panels, inverters, switchgear, protection modules and voltage transformation before interfacing the grid.

A Solar Farm provides a variety of switching equipment that handles control and switching of both AC and DC.

Circuit Breakers (CBs) can be controlled both from the front panel by means of a switch or remotely from SCADA. The isolators can for safety reasons only be manoeuvred locally.

TERCO Blocking System

There is a built-in switching hierarchy in the PST2291 which prohibits the user from wrong closing operation sequence between Isolators and Circuit Breakers (CB).

Technical Specifications

Electrical Data

Rear side I/O: 3 phase + N + PE 400V/50Hz protected by a MCB and an EF protection

Photovoltaic power in: 3 phase + N + PE 400V/50Hz (grid-tied) protected by a MCB and EF protection

DC- Switching

- DC switch-isolator 2-pole isolator, double circuit.
- DC CB Capable of switching the rated current remotely.

AC - Switching

- AC switch isolator (outdoor use) IP65. For poles, 3+N. Rated for switching nominal current
- 2 x AC switch isolators (indoor use) Four pole, 3+N. Rated for switching nominal current
- 6 x CB's 3 pole breaking of current

Measurements

Cubicle	WxHxD	1050x1900x1075 mm
Weight		245 kg

....continuation PST2291 Solar Power Module



Photovoltaic Module

The photovoltaic module consists of three solar panels framed in a sturdy Aluminum frame, designed to be mounted on ground on a stand or on a roof top. The panels together with the electrical equipment are all IP65 or higher classed, making them suitable for outdoor use in all weather conditions.

Panels Specification

3 x monocrystalline:

- Aluminum frame, designed for environments with high temperature
- Maximum Power (P_{max}): 265W
- Short Circuit Current (typical A/Isc): 8.41
- Open Circuit Voltage (typical V/Voc): 37.7

Inverter

3 x micro inverter:

- A micro inverter accompanies to each panel in order to convert the DC to AC. 250W / inverter, Grid-tied

Sensors

Light sensor:

- Measures the amount of irradiance in the current

Temperature sensor:

- Panel temperature

Panels

Three solar panels.

Each panel:

Measurements

Cubicle	WxHxD	1650 x 990 x 120 mm
		Dimension specifies panel folded down without wheels.
Weight		22 kg



PST2290 Wind Power Module

The PST2290 Wind Power Module models the inherent principles, functions and challenges in the different stages of a wind power plant project. This includes both the operation of the individual wind turbine, as well as the connection of the plant to an electrical grid. It promotes hands-on experience in order to understand and overcome the challenges when incorporating modern renewable energy power plants into classic grid topologies.

The module includes an actual smallscale wind turbine that conveys the fundamental physical, mechanical and electrical principles when harvesting electrical energy from the wind. It is mounted on a 3 m mobile and foldable mast unit that allows quick and easy setup and repositioning at an optimal location in accordance with the local wind conditions.

Weather independent simulation is also made possible by a fully programmable variable three phase power source, integrated into the PTG2290 Wind Power Module. This allows full control over wind conditions even when the weather is calm, maximizing the efficiency of student lab time.

Technical Specifications

Wind turbine type	Vertical, Upwind
Rated power	1000 W
Max power 1	200 W
Rated rotation speed	750 rpm
Start-up wind speed	6 m/s
Rated wind speed	12 m/s
Survival wind speed	50m/s
Rotor diameter	1.96 m
Swept area	3 m ²
Generator	3-phase PMA
Grid-tie inverter type	
Gridtie inverter type	3-phase
Rated power	5.5 kW

Additionally, a variable three phase electrical power source is integrated into the PTG2290 Wind Power Module, thus allowing the weather independent simulation of varying wind conditions and therefore maximizing the efficiency of student lab time.

Electrically, the module operates with a three phase permanent magnet alternator (PMA) connected to a three phase grid-tie inverter and includes all the necessary measuring, safety and display equipment for the operation of the wind power plant and execution of the provided experiments.

Aside from the three phase electrical data (voltage-current, active and reactive power as well as power factor), the data collected from the and included outdoor sensors on for wind speed, and wind direction, as well as air temperature and air pressure is displayed, logged and accessible for export.

The PST2290 Wind Power Module can function as stand alone equipment but can also easily be integrated into the Terco PTG and PST power system models and corresponding SCADA systems.



Weight

Windmill	32 kg
Mast	95 kg

Dimensions

Windmill	1120 x 420 x 430 mm
Mast	1000 x 1000 x 400 mm



PST2250-150 Terco SCADA System Master Module



To provide the best possible overview the system is delivered with 3 screens

Complete Laboratory Control and Monitoring System for the TERCO Power System Simulator PST 2200 including General Electric iFix Software package and computer.

iFIX is a superior proven real-time information management and SCADA solution, which is open, flexible and scalable. It includes impressive, latest-generation visualization tools, a reliable control engine, and more.

Full system overview is provided via a tripple screen solution including user-selected page location.

As never before, this best in class software allows you to perform better analysis and leverage more reliability, flexibility, and scalability .

Complete access rights management and administration for both groups and individuals from Viewing Only to Full Control access of selectable modules.

Easy installation of additional power system modules for trouble-free future upgrades.

Presentation of user-selected Trend Data for intuitive power system monitoring over time.

It is possible to connect multiple clients. Consequently multiple students can work simultaneously.

With the TERCO SCADA system, synchronization can be performed remotely at multiple points in the PST. Key parameters such as voltage and frequency are presented in real-time during the easy synchronization process.

All instruments, isolators and breakers, are indicated on screen even when operated from front panels. This facilitates for the teacher to study the work of the students without interfering.

The Equipment comprises:

- A. Advanced Measuring System connected on a local bus for instrumentation which through SCADA will reflect the real environment.
- B. PLC's to operate Isolators and Circuit Breakers together with auxiliary contactor functions for external connections.
- C. PLC's to control Generator Speed/Frequency and Voltage.
- D. Corresponding Software with Development Version License (Not only run-time).

Industrial SCADA system development version. Features:

Indication Modules:

- Isolator and Breaker Status Control.
- Alarm Indications from Protection Relays.
- Extraction and Visualization of Disturbance Records

Full access to protections relays including parameter setting and Disturbance Records possible via a standard web browser.

It is possible to view important analogue current and voltage sinus waveforms in a suitable graph, together with protection's binary input and output status for in-depth fault analysis after such an event has occurred. Voltage and current vectors is presented alongside the graph with the possibility to scroll to any timepoint for simultaneous waveform and vector comparison.

Monitoring of system-wide power network characteristics occur via several industrial three-phase instruments, each comprising 20 parameters, such as:

- Voltage (ph-ph, ph-N, mean ph-ph, mean ph-N)
- Current (phases and mean) which enables the possibility to monitor non-symmetrical behaviour
- Active, reactive and apparent power (both phases and mean), cos phi etc.

.... continuation PST2250-150 Terco SCADA System Master Module

Additional characteristics are monitored via single phase instruments, such as:

- Generator excitation current
- Voltage meters for bus bars

Remotely Controlled Modules:

- Motor (Turbine) Speed
- Generator Voltage
- Synchronization
- Loads
- Circuit Breakers
- Isolators
- Alarm Resetting
- Protection relay parameter settings
- Fault injections

Others:

- All Isolators and Circuit Breakers are interlocked by PLC's, to prevent faulty operation orders
- Replicates all PST 2200 System main module configurations
- Easily visualization of control and monitoring images
- Event logging (Alarm history)

The price includes the following:

- Complete hardware as above, software and software license
- Suitable high specification PC with 3 wide screens
- Manual covering essential descriptions
- Installation, commissioning and 1-2 days Basic Teacher Training at site by TERCO Engineer

Measurements:

Three screens per SCADA System as standard.
Each screen

Cubicle WxHxD 620x360x400 mm
Weight 5 kg

Computer (one computer per SCADA System):
Cubicle WxHxD 170x400x450 mm
Weight 6 kg

The dimensions and weights can vary slightly with any new screen and computer.

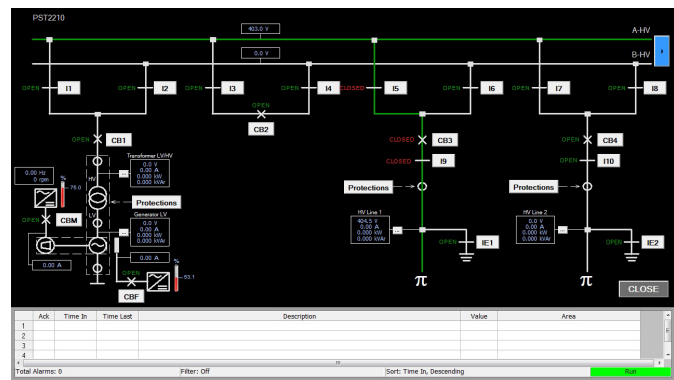
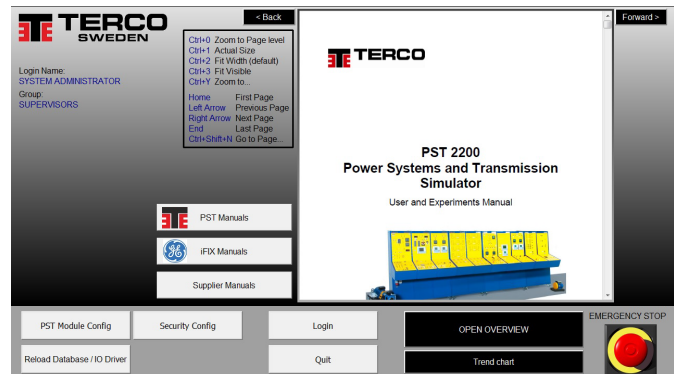

From the PST SCADA application (or Internet Explorer) the Protection Units can be accessed and configured by means of the ABB WHMI application (integrated in the Terco SCADA system). Below an example from the main page of a protection unit when a trip has occurred:

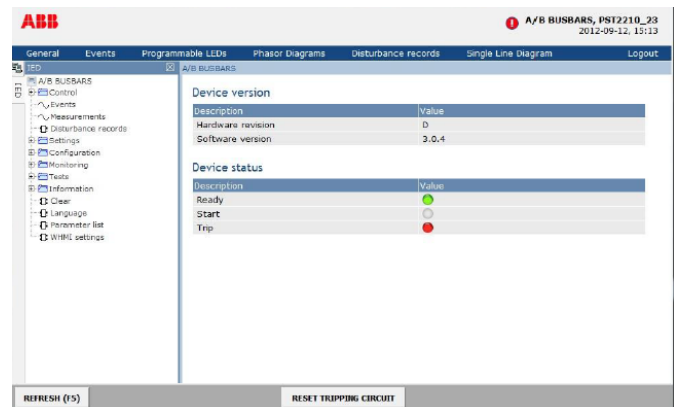

PST2252-1 Terco SCADA System Student Module



PST2252-1 SCADA Student Terminal contains:

- Suitable PC with wide screen
- Software license and communication card for connection to Master PC
- Necessary cables and components for connection to master PC in the same room

One SCADA Terminal can be able to control the whole PST system like the Master PC with the possibility to limit rights from Full Administrator Control to View Only Access.

This choice should be set from the Master PC via access rights management console.

Student Terminal requires SCADA iFix Master. Up to 64 students Terminals can be connected.

Full access to protections relays including parameter setting and Disturbance Records should be possible via a standard web browser.

It should be possible to view important analogue current and voltage sinus waveforms in a suitable graph, together with protection's binary input and output status for in-depth fault analysis after such an event has occurred.

Voltage and current vectors should be presented alongside the graph with the possibility to scroll to any timepoint for simultaneous waveform and vector comparison.

Measurements

Screen

Cubicle WxHxD 620x360x400 mm
Weight 5 kg

Computer

Cubicle WxHxD 170x400x450 mm
Weight 6 kg

The dimensions and weights can vary slightly with any new screen and computer.

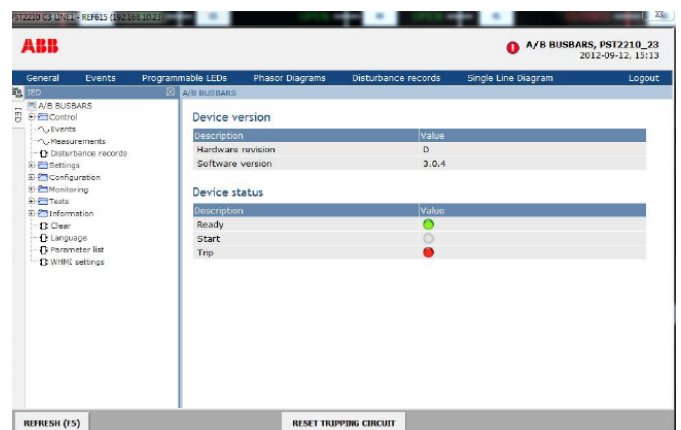
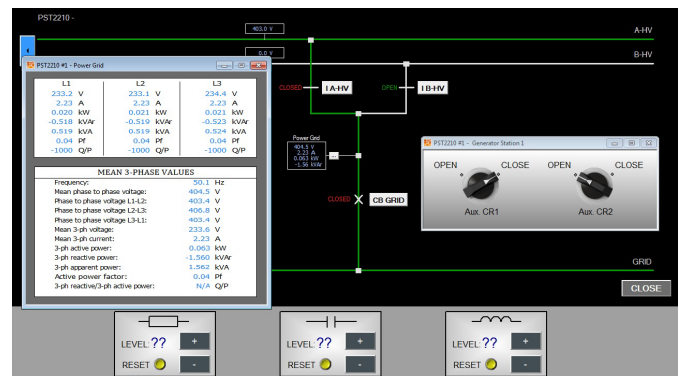
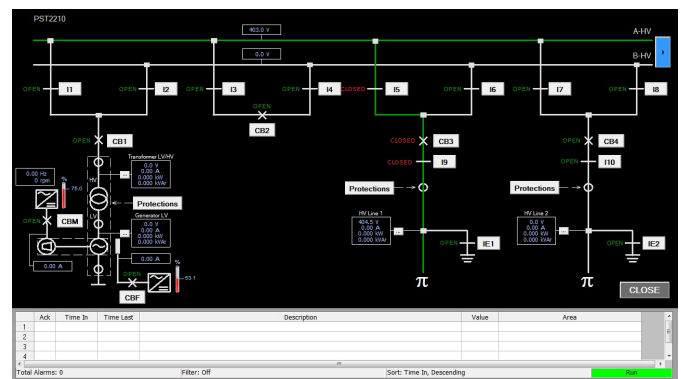
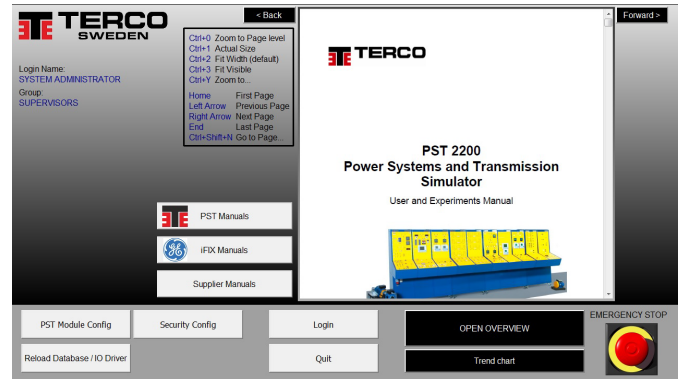

PST-Inst 1 Installation and Teacher Training



The installation is about 5 days and includes:

- Installation: TERCO presumes all necessary wiring and foundation to be ready according to instruction from TERCO prior to arrival of TERCO representative.
- Final Designation of Modules
- Electrical Internal Connection
- Electrical Installation to Main Supply
- Testing of Individual Modules
- Final Testing of the whole system.

All equipment packed in original crates. Unpacking are to be done together with TERCO representative.

The installation requires the support of one of your technicians.

Basic Teacher Training:

The proposed installation covers at the same time training with the system and presumes that the teachers are well familiar with electric power, theoretically and practically.

More comprehensive courses can be arranged at site or in Sweden and they can be tailor made according to customer requirement.

The training covers:

- Use of manual
- Technical Structure of the System including explanation of layout, external connections, internal connections and communication
- Starting, stopping and running the system for normal operation
- Operating the measuring systems
- Operating the CB and Isolators logical interlocking systems
- Performing a choice of experiments
- Performing a choice of network configurations
- The concept of synchronizing to a second generator or power source (if applicable)
- Fault Simulation Basic Service

ORDER DETAILS POWER SYSTEMS SIMULATOR

Order code	Description	Pcs Level 1	Pcs Level 2	Pcs Level 3	Page
PST2210-IED1	Power Plant Module, IED Level 1	1			8-10
PST2210-IED2	Power Plant Module, IED Level 2		1		8-10
PST2210-IED3	Power Plant Module, IED Level 3			1	8-10
PST2221	Transmission Lines Module	1	1	1	11
PST2222	Distribution Lines Module	1	1	1	14
PST2230-IED1	Receiving Substation Module, IED Level 1	1			12,13
PST2230-IED2	Receiving Substation Module, IED Level 2		1		12,13
PST2230-IED3	Receiving Substation Module, IED Level 3			1	12,13
PST2240	Load Module	1	1	1	15
PST2250-150	Terco SCADA System Master Module, 3 screen solution	1	1	1	23,24
Additional Modules					
PST2212	Mobile Additional Generator Module	1	1	1	17,18
PST2280	Power Factor Control Unit	1	1	1	16
PST2231	Power Grid Switchgear Module	1	1	1	19,20
Optional (one unit of each)					
PST2252-1	Terco SCADA System Student Module, 1 screen solution	1	1	1	25
Renewable Power modules					
PST2290	Wind Power Module	1	1	1	22
PST2291	Solar Power Module	1	1	1	20,21
Installation and Teacher Training					

Ref. 101,102,103

TERCO AB was founded in 1963 with the aim of producing and supplying practically oriented equipment for technical education.

TERCO develops, manufactures and markets advanced equipment and systems for technical education. TERCO is today represented in more than 50 countries world wide.

TRAINING FOR TOMORROW'S WORLD



Electrical Machines & Drives



High Voltages lab



Power Systems

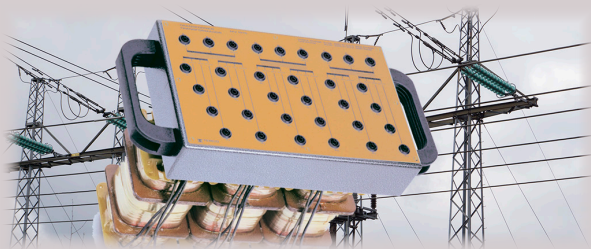

Transmission



Process, Control & Servo System

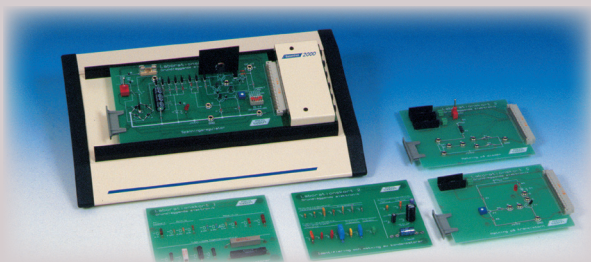

Electronics & Mechatronics



Automotive Electronics



Material Testing



Power Distribution & Furniture for Lab